

I N F O



INSTALLATION AND INSTRUCTION MANUAL
WASHING MACHINES EW 705 F - EW 803 F

 **Electrolux**

CONTENTS

Warnings	page 3
Installation instructions	page 4
Transportation security devices	page 4
Positioning and connections	page 5
Levelling	page 6
Use	page 7
Control panel	page 7
Symbols and controls	page 7
Washing programmes	page 8
Operation sequence	page 10
Washing hints	page 12
Temperatures and detergents	page 12
International wash care symbols	page 14
Maintenance	page 15
External cleaning	page 15
Washing powder dispenser drawer	page 15
Water drain filter	page 15
Water inlet filter	page 16
Something not working?	page 17

TECHNICAL SPECIFICATIONS

		EW 705 F	EW 803 F
DIMENSIONS	Height	85 cm	85 cm
	Width	60 cm	60 cm
	Depth	52 cm	52 cm
VOLTAGE/FREQUENCY		220-230V / 50Hz	220-230V / 50Hz
MAXIMUM POWER ABSORBED		2250 W	2250 W
FUSE MINIMUM POWER		10 A	10 A
WATER PRESSURE	min.	5 N/cm ²	5 N/cm ²
	max.	80 N/cm ²	80 N/cm ²
MAXIMUM RECOMMENDED LOAD	Cotton, linen	5 kg	5 kg
	Synthetics, delicate fabrics	2 kg	2 kg
	Wool	1 kg	1 kg
SPIN SPEED	Maximum	600 rev./min.	800 rev./min.

This appliance conforms to E.E.C. directive N. 87/308 of 2/6/87 regarding the suppression of radio interference.

WARNINGS

It is most important that this instruction book should be retained with the appliance for future reference. Should the appliance be sold or transferred to another owner, or should you move house and leave the appliance, always ensure that the book is supplied with the appliance in order that the new owner can be acquainted with the functioning of the appliance and the relevant warnings.

These warnings are provided in the interest of safety. You must read them carefully before installing or using the appliance.

- This appliance is designed to be operated only by adults. Children should not be allowed to tamper with the controls or play with the product.
- It is dangerous to alter the specifications or attempt to modify this product in any way.
- Any electrical work required to install this appliance should be carried out by a qualified electrician or competent person.
- Any plumbing work required to install this appliance should be carried out by a qualified plumber or competent person.
- This product should be serviced by an authorized Service Centre, and only genuine spare parts should be used.
- Care must be taken to ensure that the appliance does not stand on the electrical supply cable.
- Always unplug the appliance and turn off the water after use.
- Do not overload the appliance. Follow the instructions in the relevant section of this booklet.
- Before opening the door, check through the glass door if the water has drained completely. If water is present, do not open the door before draining the water. If in doubt, refer to your instruction booklet.
- This appliance is heavy. Care should be taken when moving it.
- All packing and transit bolts must be removed before use. Serious damage can occur to the product and to property if this is not adhered to. See relevant section in instructions.
- If the appliance stands on a carpeted floor, ensure that air can circulate freely between the feet and the floor.
- Leave the porthole door slightly ajar between washes to preserve the door seal.
- The glass door may become very hot during the washing cycle. Keep children away from the vicinity of the appliance whilst it is in operation.
- Only wash garments which are designed to be machine washed. If in doubt, consult the manufacturer of the item or follow the instructions you find on the label of the item itself.
- Before washing, ensure that all pockets are empty and buttons and zips are fastened.
- Avoid washing frayed or torn articles and treat stains such as paint, ink, rust and grass before washing. Underwired bras must not be machine washed.
- Any objects such as coins, safety pins, nails, screws, stones or any other hard or sharp material can cause extensive damage and must not be placed into the appliance.
- Garments which are saturated with petroleum products should not be machine washed. If volatile cleaning fluids are used, care should be taken to ensure that the fluid is removed from the garment before placing it into the machine.
- Wash small items such as socks, laces, washable belts etc. in a pillow case as it is possible for such items to slip down between the tub and the inner drum.
- Only use the advised quantities of fabric softener. Damage to the fabric can ensue if you over-fill. Refer to the manufacturer's recommendations of quantities.
- Pets or little children might climb into the washing machine. Always check your drum before use and do not allow children to play with the machine.
- Under no circumstances should you attempt to repair the machine yourself. Repairs carried out by inexperienced persons may cause injury or more serious malfunctioning. Contact your local Service Centre. Always insist on genuine spare parts.

INSTALLATION INSTRUCTIONS

Transportation security devices

Before starting the machine it is indispensable to remove the transportation security devices as follows.

Unscrew and remove the rear right screw using a spanner.

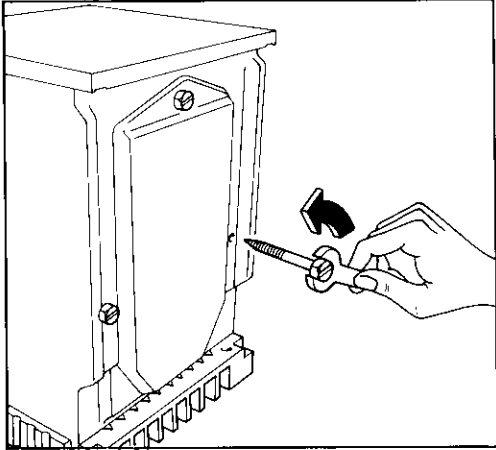

Remove the polystyrene block from the bottom of the machine.

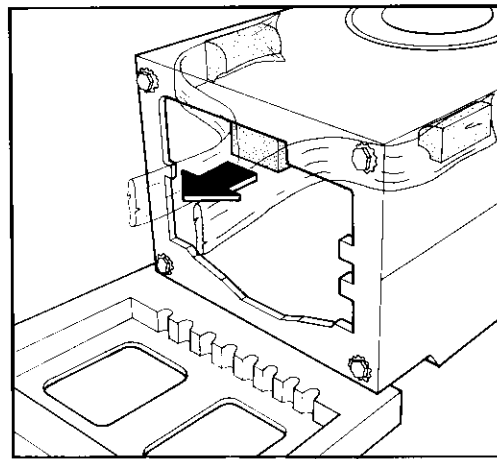

Carefully slide out the right polythene bag, removing it towards the centre of the machine.

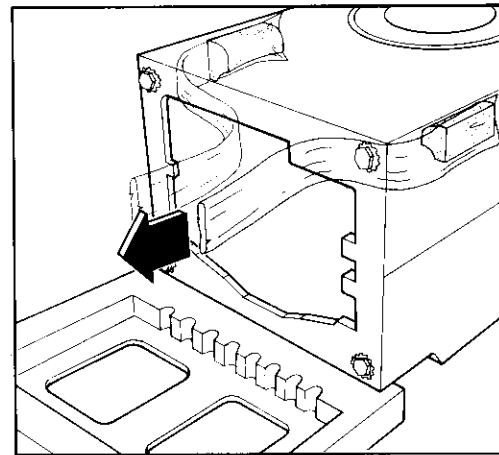

Lay the machine on its back making sure that the hoses are not squashed.

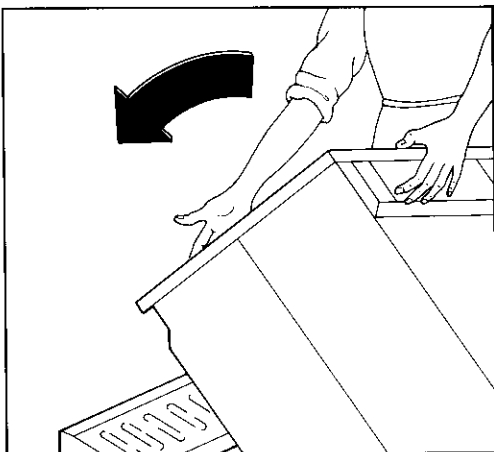

Repeat the operation for the left polythene bag, removing it towards the centre of the machine.

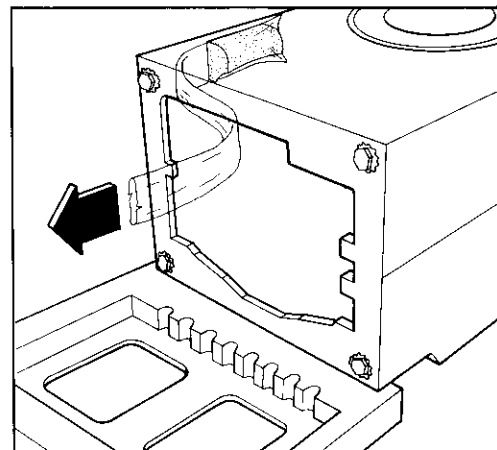

Remove the polystyrene base, set the machine upright and unscrew the two remaining rear screws.

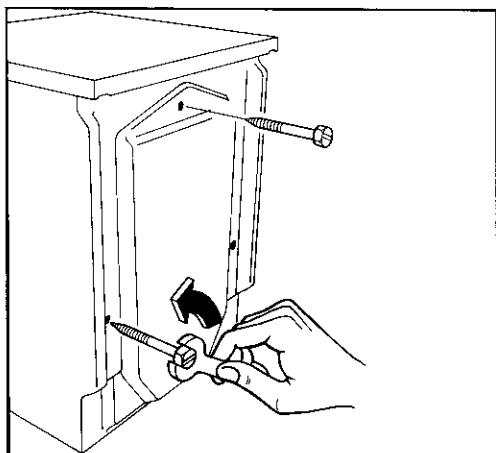

Plug the 3 holes with the 3 plastic plugs which you can find on the back of the machine.

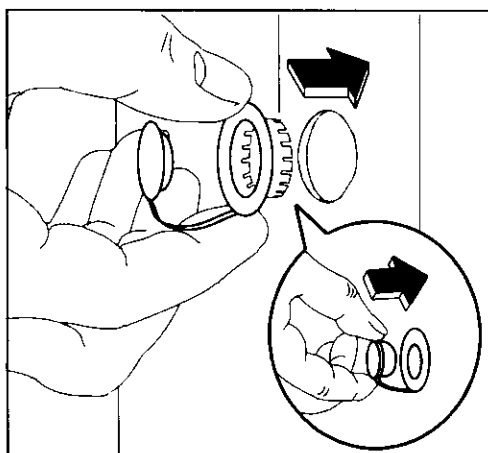

Slide out the 3 plastic pins.

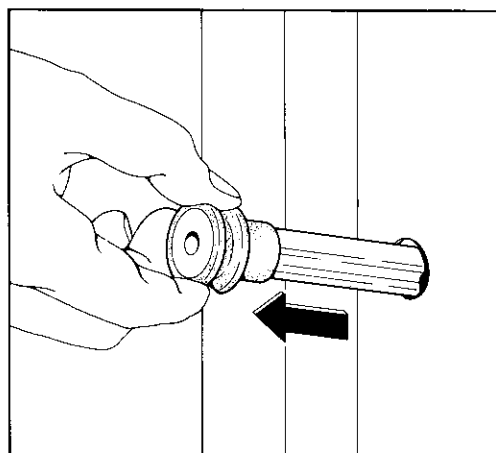

Note

It is advisable to keep all the transportation and packing security devices: they will be used in case the machine has to be transported again.

Positioning

Position the washing machine on a firm level floor; it must not touch the wall, other furniture etc. Beside the washing machine there must be a tap for inlet of the water, a sink or basin for water drainage and a power supply socket. If the water drains directly into a drain pipe, have it checked by a plumber or by the installer.

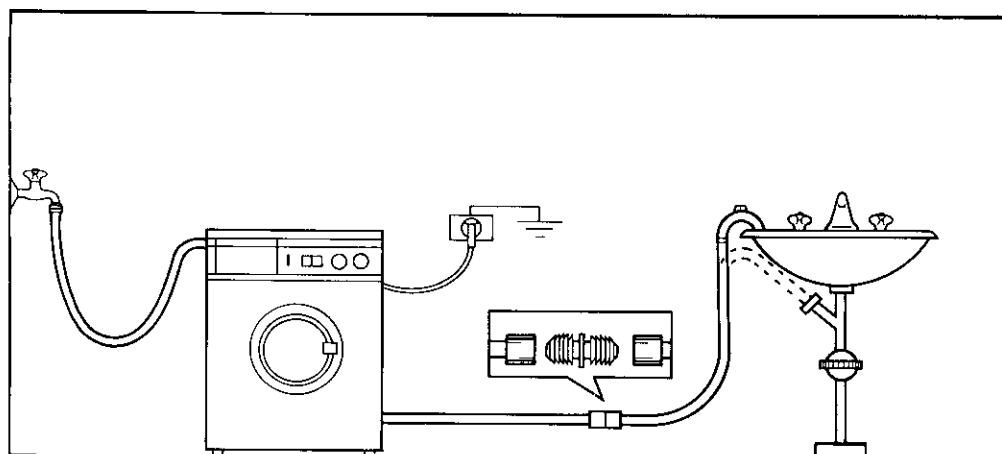

Water inlet

Connect the water inlet hose to a tap with a 3/4" gas thread spout after fitting the rubber filter supplied with the machine.

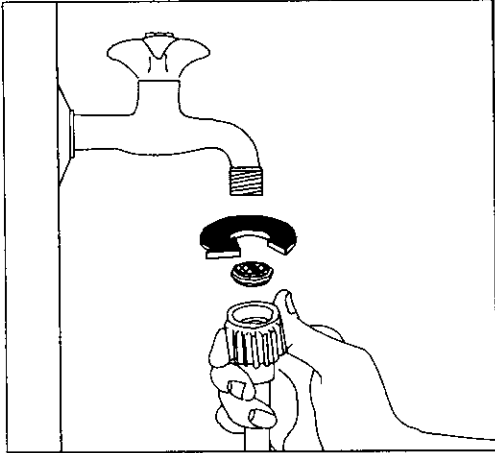

Set the hose correctly by loosening the ring nut. Then tighten the ring nut again to prevent leaks.

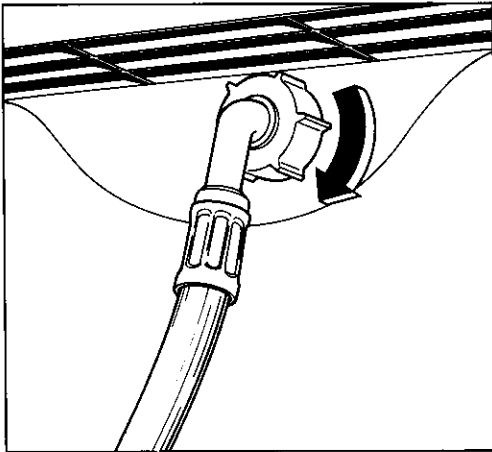

Water drainage

Fit the spout of the drain hose over a sink or basin. Position the drain spout at a height of between 60 and 90 cm. If an extension hose is required, it should not be longer than 180 cm and must have the same internal diameter as the original drain hose. Depending on the position of the sink or basin, the drain hose can be turned either to the right, to the centre or to the left.

To keep the drain hose spout bent, use the special plastic hose guide supplied with the machine, which can be used to secure the hose to a wall to prevent it from moving during rinsing cycles and thus causing floods.

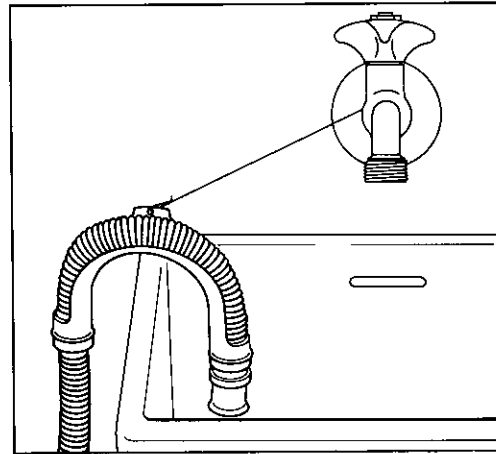

Electrical connection

Before plugging the appliance into the wall socket, make sure that:

the mains voltage corresponds to the voltage given in the technical specifications;

the meter, fuses, mains power supply and wall socket can all take the maximum load required.

Make sure that the socket and plug are compatible without having to use any type of adapter. If necessary, have the domestic wiring system socket replaced.

Safety standards require the appliance to be earthed.

The Manufacturer accepts no liability for failure to observe the above safety precautions.

Levelling

Level the washing machine by loosening or tightening the feet. Accurate levelling prevents vibrations, noises and displacement of the washing machine during operation. After levelling the machine, secure the feet by tightening the ring nuts.

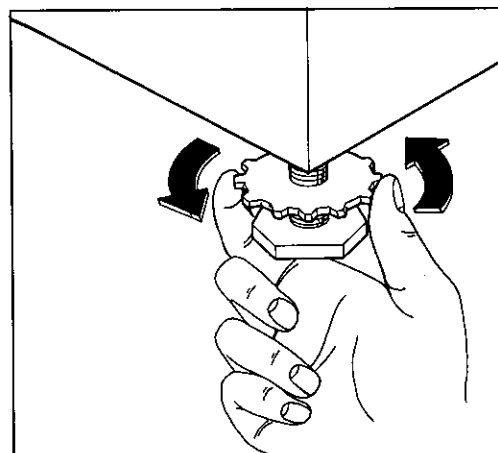



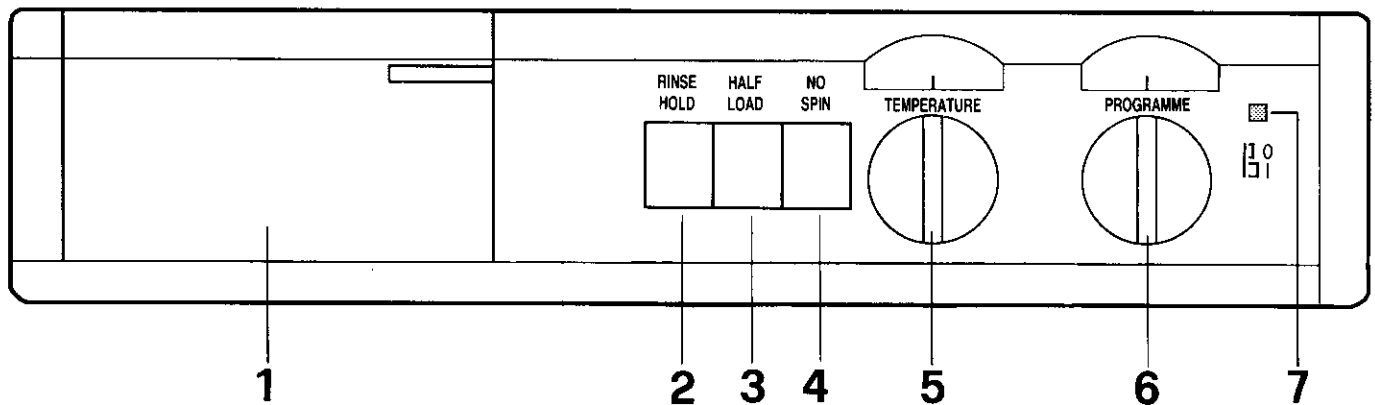

Control panel



- | | |
|---|------------------------------|
| 1 Washing powder dispenser drawer and programme guide | 5 Temperature selection dial |
| 2 RINSE HOLD button | 6 Programme selection dial |
| 3 HALF LOAD button | 7 Pilot lamp |
| 4 NO SPIN button | |

Symbols and controls

-  Symbol for "prewash". This symbol is also found in the washing powder dispenser drawer to be used for the prewash.
-  Symbol for "main wash". This symbol is also found in the compartment for the detergent to be used for the main wash.
-  Symbol for "bleaching". This symbol is also found in the compartment to be used for the bleach.
-  Symbol for "softener". This symbol is found in the compartment for the softener.
-  Wool washing programme; it is approved by the IWS and is to be used only for wool garments carrying the guarantee label "pure new wool" - washing shrink resistant.

RINSE HOLD Press this button with the washing programme for synthetic or delicate fabrics in order to block the water drainage of the last rinse. This avoids creasing when the laundry is left inside the machine at the end of the washing. In order to drain the water afterwards, you only need to press the button again.

HALF LOAD Select this button to reduce water consumption on the rinse cycle when washing a smaller load of cottons or linens. (Maximum load size = 2.5 kg).
You can also use the Half Load button together with Programme F if you wish to rinse a small load

NO SPIN Press this button when you wash cotton or linen clothes that are particularly «delicate» in order to exclude all of the spin phases.

TEMP. To select the washing temperature press the dial in and then turn it to the required value. The maximum recommended temperatures for all types of laundry are shown in the programmes tables.

When your laundry is only lightly stained, the temperatures shown can be reduced and even a cold wash can be used (dial to position X).

In this way you will also save electricity.









PROG. Use this dial to select the required washing programme. Press the dial in and turn it **clockwise**.

 To start the machine pull the knob outwards, to stop it press the knob in.

 The pilot lamp will come on when the machine starts operating.

Programmes for cotton and linen

Recommended load: max. 5 kg









Programme	Degree of soil	Compartment- ments to use	Thermostat dial position	Programme dial position	Cycle description
Whites	Heavy soil		95	A	Prewash Wash at 95°C Rinses Spin
Whites	Heavy soil		60 E (*)	A	Prewash Prolonged wash at 60°C Rinses Spin
Whites	Normal soil		95	B	Wash at 95°C Rinses Spin
Whites	Normal soil		60 E (*)	B	Prolonged wash at 60°C Rinses Spin
Fast coloureds	Normal soil		60	C	Wash at 60°C Rinses Spin
Non-fast coloureds	Normal soil		30-40 (**)	D	Wash at 30-40°C Rinses Spin
Rinses				F	Rinses with bleach if required Spin
Special treatments				G	Rinse with additives if required Spin
Spin only				H	Draining of water and long spin

(*) For an economy wash, you can select 60°C instead of 95°C.

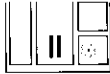
(**) A temperature of 30-40°C means that the user can select either a temperature of 30°C or 40°C.

Programmes for synthetics, delicates, silk and wool

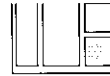
Recommended load: max. 2 kg (wool 1 kg)

Programme	Degree of soil	Compartment- ments to use	Thermostat dial position	Programme dial position	Cycle description
Whites	Heavy soil		60	J	Prewash Wash at 60°C Rinses Water drainage (**)
Whites	Normal soil		60	K	Wash at 60°C Rinses Water drainage (**)
Whites	Normal soil		40 E (*)	K	Prolonged wash at 40°C Rinse Water drainage (**)
Delicates	Normal soil		40	L	Wash at 40°C Rinses Water drainage (**)
Silk	Normal soil		30	L	Wash at 30°C Rinse Water drainage (**)
Woolens 	Normal soil		40	M	Wash at 40°C Rinses Water drainage (**) Special programme for "pure new wool" garments - washing shrink resistant
Rinses				N	Rinses with additive, if required Water drainage (**)
Special treatments				P	1 rinse with additive, if required Water drainage (**)
Drain				Q	Draining of water

(*) For an economy wash you can select 40°C instead of 60°C.

(**) If you have pressed the RINSE HOLD button, the washing machine will stop, at the end of the last rinse, with the water left in the tub, to avoid the forming of creases. In order to drain the water, press the RINSE HOLD button again or, if the laundry can be spun (e.g. wool), select programme H (spin).

WASHING SEQUENCE

1 Place the laundry in the drum

Open the loading door by pulling the catch outwards. Place the garments to be washed inside the drum one by one laying them as flat as possible. Close the door ensuring that the catch clicks into place.



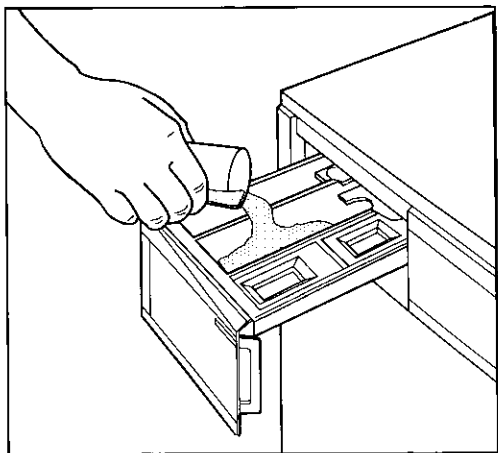

2 Measure out the washing powder

Pull out the drawer. Measure out the required quantity of detergent in a dispenser and place it in the compartment marked with the symbol .



If you have selected a programme with prewash, place the washing powder in the relevant compartment .

3 Measure out the additives

If needed, pour the softener into the compartment  and, if required, the bleaching agent into the compartment . Do not exceed the max. level.

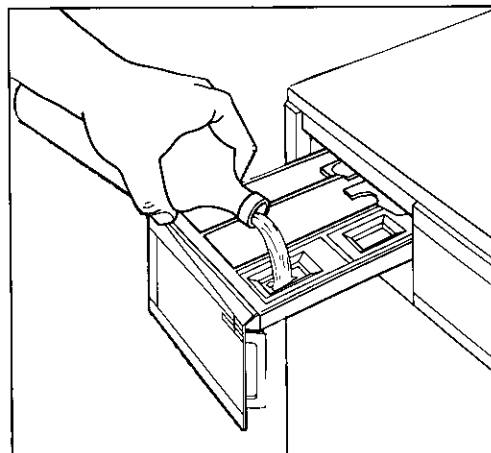

4 Select the temperature

Press and turn the thermostat dial to the desired temperature.

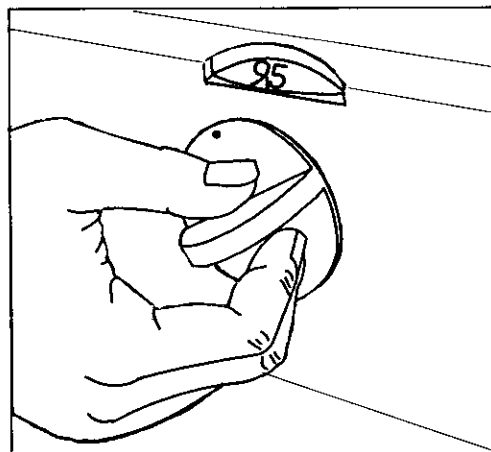

5 Press the button/s required

6 Select the programme

Press the programme dial in and turn it to the right on the required washing programme.

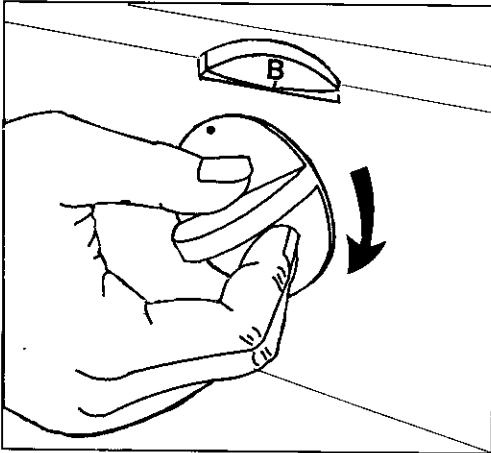

8 At the end of the programme

The machine stops automatically and the pilot light goes out.

Push the programme selector dial in.

The door is controlled by a safety device which releases it 1-2 minutes after the end of the programme.

Unplug the appliance and turn off the water tap.

Depress the button/s.

Open the door and take out the laundry. Turn the drum once with your hand to check whether it is really empty.

Leave the door ajar to let vapour out.

7 Start the machine

Plug into the mains.

Turn on the water tap.

Check that the drain hose is correctly positioned.

Pull the programme selector dial outwards.

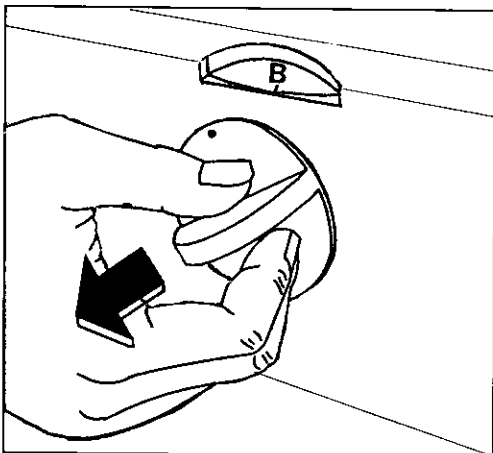

The pilot light comes on and the washing machine starts up.

SOME WASHING HINTS

First of all it is advisable not to keep the soiled laundry for too long before washing it, especially if it is damp (it is likely to go mouldy or to get a musty smell).

Sort your laundry

Study carefully the chart in this booklet explaining the symbols used on clothes labels.

The following points are particularly important:

a **line** under the bowl means that the garment cannot be washed using programmes for resistant fabrics as cotton and linen;

do not mix coloured garments with whites;

antcrease materials like polyester/cotton should be treated as synthetics;

non-resistant fabrics like acrylic and most curtain materials should be treated as delicate fabrics;

the wool washing programme is designed specifically for pure new wool. Other types of wool and wool mixtures may shrink or felt if machine-washed.

Woollen garments should be spun briefly immediately after washing.

Prewash

Prewash is usually not needed. You may use it in case of very soiled laundry, such as garments used by butchers or workmen.

Temperatures

It is advisable to wash white fabrics at a temperature of 60°C and not of 95°C. If the laundry is only lightly soiled, this temperature will be fully sufficient and will allow you to save a lot of electrical power.

It is enough to wash at 40°C the colour-resistant fabrics, which resist a maximum temperature of 60°C. When washing together dark and light coloured items, temperature should not exceed 40°C.

White and light-coloured synthetic fabrics may usually be washed at a temperature of 60°C, but in this case 40°C will be enough if the laundry is not too soiled.

Dark coloured synthetic fabrics, delicate fabrics and wool must be washed at a temperature below 40°C. If in some label a temperature of 30°C is recommended, select 30°C for the whole washing. An article of this kind may mostly be washed at 40°C, but the Manufacturer cannot run the risk of damaging delicate garments. Any choice is up to the user.

You are personally responsible for eventual damage caused by a wrong choice (too high temperature).

Among international symbols for the treatment of fabrics there may still be found a temperature of 50°C (British) and of 70°C (American). In these two cases, it is possible to wash the item in question at a temperature of 60°C.

This washing-machine, as has already been said, also has a "cold wash" programme. Nevertheless, it must be taken into account that detergents are not very suitable for this kind of washing. Moreover, in winter, since the water is very cold, they do not easily dissolve.

Load

The laundry should always be weighed.

As far as cotton and linen are concerned (white and coloured fabrics), you must not load more than 5 kg of dry laundry.

Not more than 2 kg of synthetic fabrics and not more than 1 kg of wool.

Since it is difficult to weigh the laundry, it is advisable to follow a different method:

- Cotton, linen, mixed linen: drum full, without pushing.
- Resistant synthetics: not more than two thirds of the drum.
- Delicate fabrics and wool: not more than half of the drum.

Before loading the machine

Before washing, mend tears, holes and frayed threads.

Fasten or remove loose buttons.

Close poppers and zips.

Avoid washing frayed garments and mend the hems before washing.

Before washing empty all pockets of small objects which may have been left inside. Nails, pins, buckles and alike may cause serious damage to the machine and to the garments.

Remove the hooks which fasten the curtains.

Wash new coloured items alone, especially if dark-coloured, because when washing for the first time they are very likely going to discolour.

Before washing, treat difficult stains (such as those of grass, rust, coal tar, paint, biro) with a stain-remover.

If, for instance, to remove a stain paint you use a volatile cleaning fluid such as turpentine or alike, before washing the item in question you must wait for the product to evaporate.

The Manufacturer disclaims any responsibility for damage or harm caused by the use of volatile, inflammable or toxic products.

Detergents

There are many different kinds of detergents: in powder or liquid, more or less concentrated, multi-purpose or others for special fabrics. In reality, though, you never use more than 2 or 3 kinds at most.

Soap or products for hand-washing should never be used because, being unfit for washing-machines, they might cause relevant damage to the machine and to the laundry.

If you use a liquid product, you can pour it directly into the **III** wash compartment, provided you do not select a prewash and you start up the washing-machine immediately. Liquid detergents are recommended for low temperatures, that is between 30 and 40°C; instead, it is advisable to use a powder detergent for higher temperatures from 60 to 95°C.

If you wish to select a prewash before the main wash, you must use a powder detergent. Use a multipurpose product for the main wash and a biological detergent for the prewash.

There are specific products for machine-washable coloured fabrics, delicate fabrics and wool. It is advisable to use such products, particularly in the case of delicate and wool fabrics.

If, for instance, you wish to tumble dry synthetic fabrics, it may be advisable to use a liquid softener since it avoids charging the garments with static electricity during washing. Do not exceed the maximum level in the softener compartment.

“Concentrated” powder detergents

Measure out the concentrated powder detergent directly into the machine drum, before loading the laundry.

The washing-machine incorporates a recirculation system which allows an optimal use of the concentrated detergent.

Avoid selecting programmes including prewash when concentrated detergents are used.

Avoid use of the proportioners supplied with the detergents into the internal drum.

Quantity of detergent

For the first washings, use the quantities indicated by the manufacturer on the detergent packet, according also to the hardness of the water. If you do not know the degree of hardness of the water, address to your local water authority.













If you have loaded just half of the drum, you may of course reduce the quantity of detergent accordingly; begin by reducing it by 25% of the expected amount.



Detergents contain softening substances which fix the lime; for this reason you must increase the quantity of detergent used proportionally to the increased hardness of the water. If the softening substances are too scarce, the laundry, particularly when selecting high temperatures, will gradually become greyish and rough. If the water is calcareous, a higher quantity should be used or, if using less detergent, the difference may be balanced with a softening agent.





Do follow the indications given in the packets.





INTERNATIONAL WASH CARE SYMBOLS







The labels found on the garments are a useful help for the treatment and care of your laundry.

<p>STRONG WASH</p>   <p>DELICATE WASH</p>	 <p>Wash at 95°C</p> 	 <p>Wash at 60°C</p> 	 <p>Wash at 40°C</p> 	 <p>Wash at 30°C</p> 	 <p>Hand wash</p>	 <p>Do not wash</p>
---	---	---	---	---	--	--

 <p>BLEACHING</p>	 <p>Bleach in cold water</p>	 <p>Do not bleach</p>
---	---	--

 <p>IRONING</p>	 <p>Hot iron max 200°C</p>	 <p>Warm iron max 150°C</p>	 <p>Lukewarm iron max 110°C</p>	 <p>Do not iron</p>
---	---	--	--	--

 <p>DRY CLEANING</p>	 <p>Dry cleaning in all solvents</p>	 <p>Dry cleaning in perchlorethylene petrol, pure alcohol R111 and R113</p>	 <p>Dry cleaning in petrol pure alcohol and R113</p>	 <p>Do not dry clean</p>
--	---	--	---	---

 <p>DRYING</p>	 <p>Flat</p>	 <p>On the line</p>	 <p>On clothes hanger</p>	 <p>Normal drying</p>  <p>Delicate drying</p> <p>Tumble dry</p>	 <p>Do not tumble dry</p>
--	---	--	--	---	--

MAINTENANCE

External cleaning

If you wish you can clean the outside of the machine with lukewarm water and detergent. Do not use abrasive products. Rinse with clean water and dry with a soft cloth.

Important: do not use methylated spirit, diluents or similar products.

Cleaning the washing powder dispenser drawer

In the long run, the detergents and the softening agents may leave deposits. From time to time clean the washing powder dispenser drawer flushing it under a fast running tap. To remove the drawer completely press the left end button.

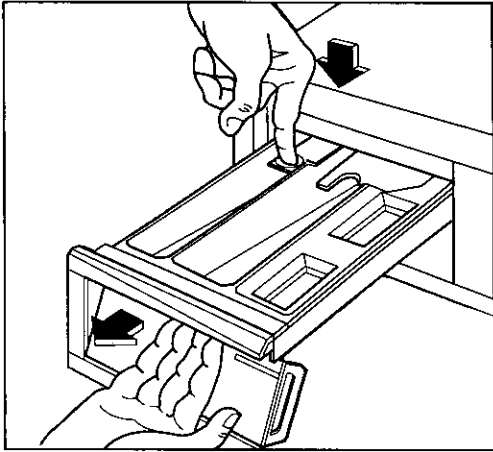

The upper part of the additive compartment can be removed for easier cleaning.

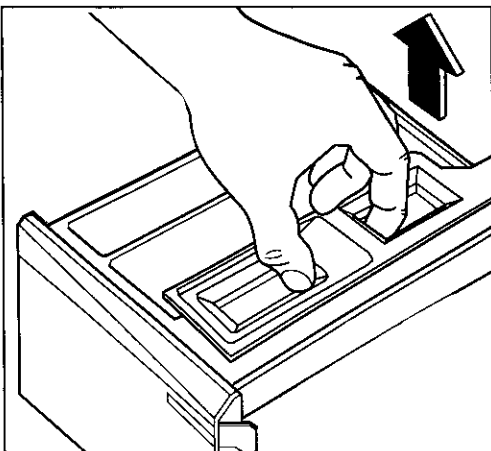

Cleaning the drawer recess

In the long run, detergent deposits may also accumulate here: clean the drawer recess using an old toothbrush. Replace the drawer and run a rinse cycle without any clothes.

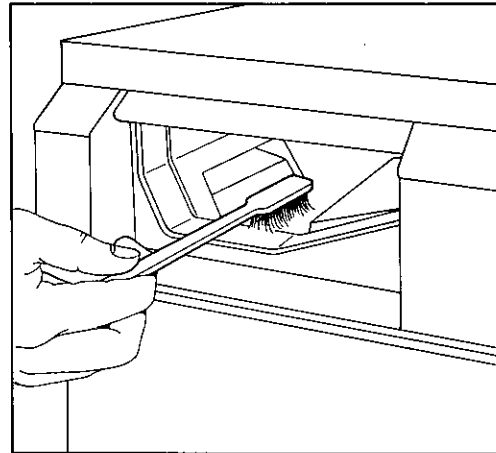

The water drain filter

The function of the filter is that of collecting threads and small objects which have been left in the items to be washed. The obstruction of the filter causes irreversible irregularities of the programme. It should therefore be periodically cleaned.

Open the filter door.

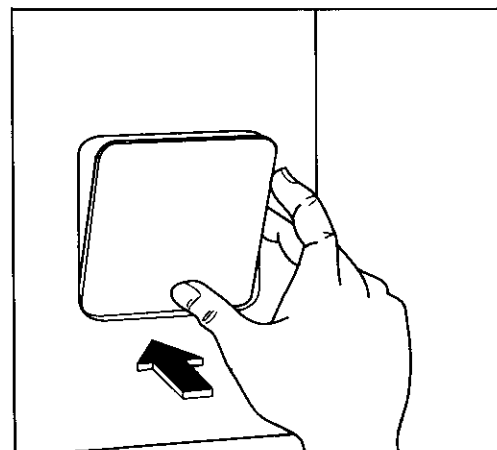

Put a bowl under the filter and unscrew it.

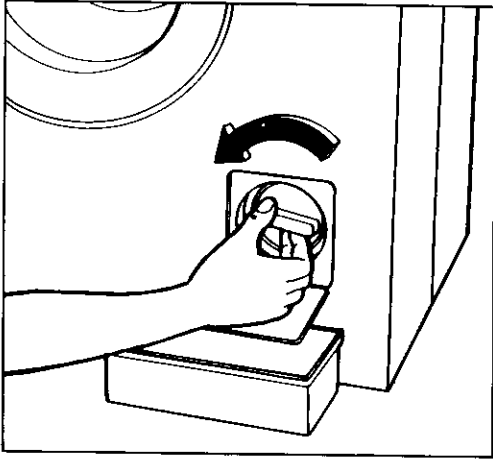

Remove the filter.

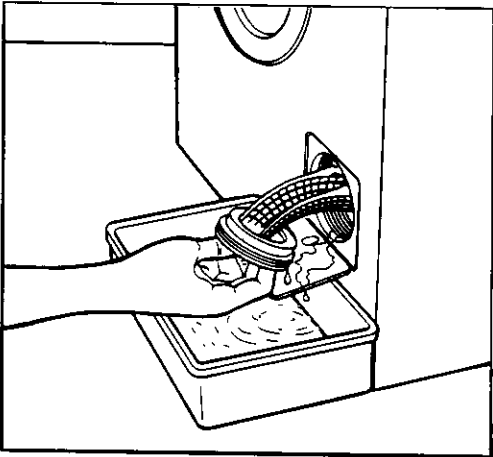

Clean carefully under a fast running tap.

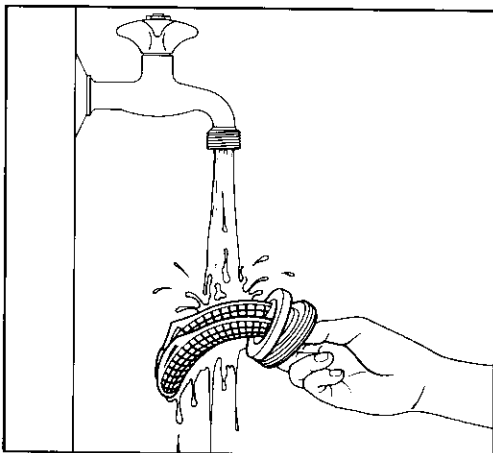

The water inlet filter

If you realize that it takes too long for the machine to fill up with water, you must check whether the water inlet filter has become clogged. Turn off the water inlet tap. Unscrew the water inlet hose from the tap. Remove the filter by means of pincers. Clean it using a brush and replace it. Accurately tighten up the inlet hose ring.

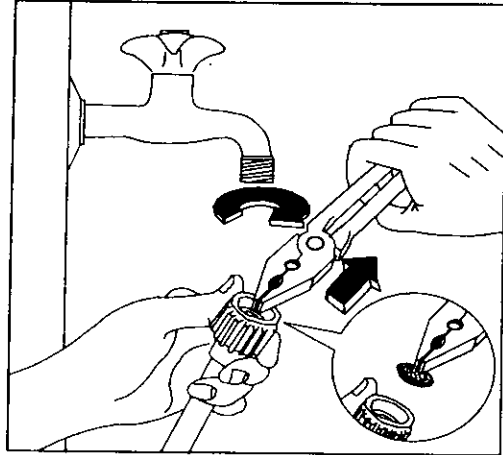

SOMETHING NOT WORKING?

The machine does not start up

After selecting a programme by pressing the relevant buttons, the machine does not start up and also the pilot light does not switch on.

- Check if the door is properly closed.
- Check if the fuse is intact.
- If you have started up the washing-machine while the tumble drier was plugged in the same socket, the fuse has almost certainly burnt.

The machine does not start up, but the pilot light is on

- Check if the water tap is on.
- Check whether the water is regularly supplied.
- Verify if the inlet hose is bent or caught up.
- Check whether the water inlet filter is clogged.

The machine empties as it fills

- The end of the drain hose is too low. See relevant chapter in this instruction booklet.

The machine does not drain and/or does not spin

- Check whether the drain hose is caught up or bent.
- Check if the drain filter is clogged.

The machine leaks

- Probably there is too much washing powder.
- Maybe the washing powder is not suitable because it produces too much foam.
- Check whether there are any leaks from one of the water inlet hose locking rings. Since it is difficult to see the water running along the hose, check whether it is humid.

The machine vibrates or is noisy

- Verify if all the internal packings have been removed.
- Check whether the machine leans against something.
- Verify whether the feet are well grounded on the floor and whether the lock nuts are well screwed.

If, after these checks, the problem persists call your nearest authorized Servicing Centre indicating the type of fault, product number and serial number, since these data will be required to you.

